



Unterrichts- u. Arbeitsblatt

P/ 355-4

Blatt 2

Ausg. 1

1.4.64

f h

Drehwähler mit Wälzmagnet

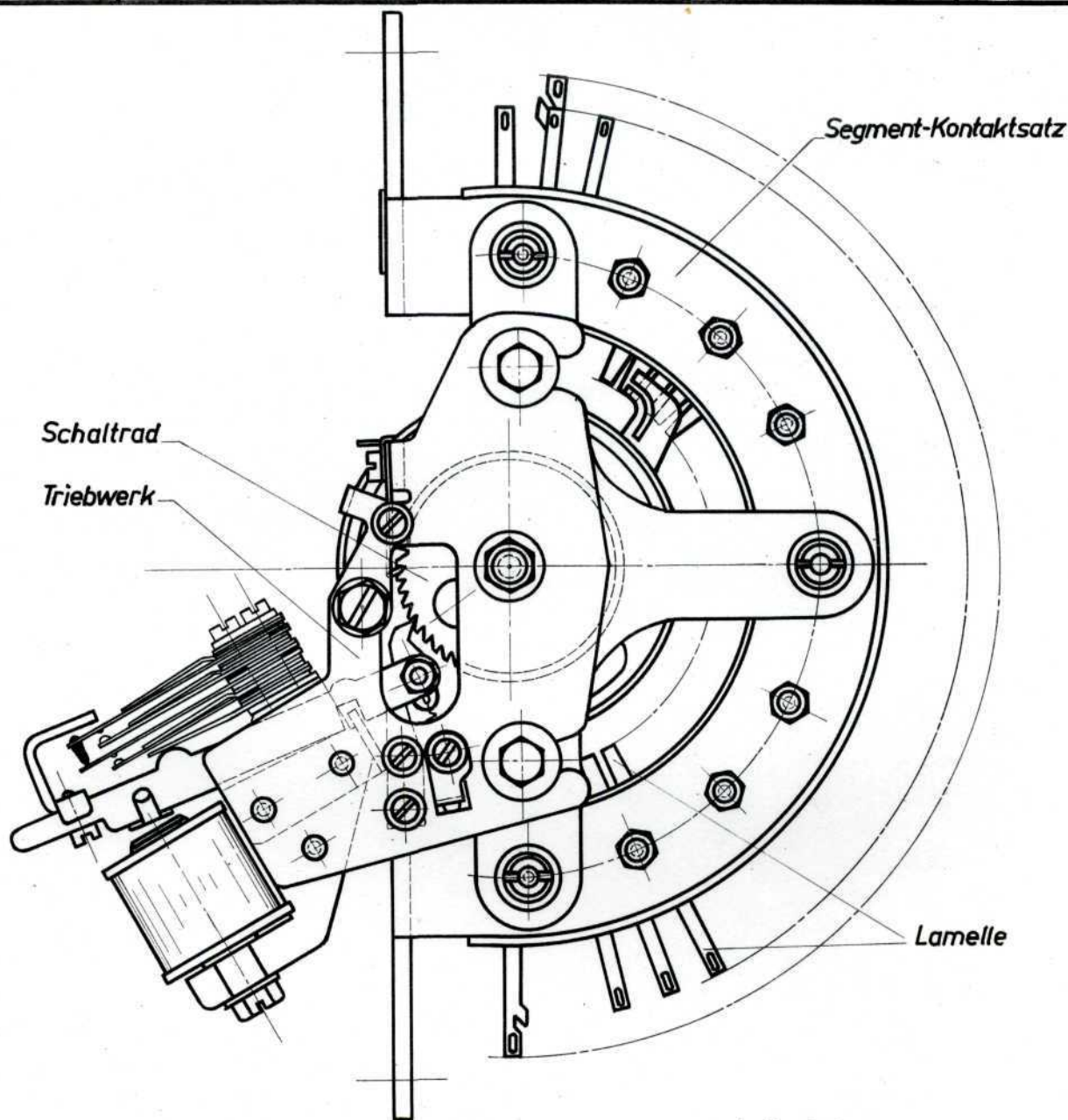

Schaltarm-Einlauf

Stromzuführungs-feder

Auflauf der Schaltarme

Lamelle

Schleiffeder



falsch



richtig

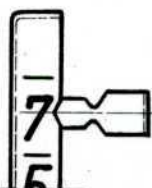

Schrittanzeige

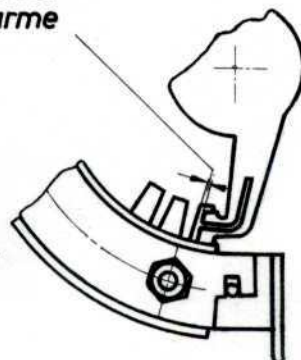
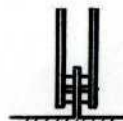

Telefonbau und Normalzeit
Frankfurt/Main
Ausbildungsabteilung

Ausg.	Tag	Name

Maßstab

Tag

Name

Gez.

10. 12. 63

Aliabadi

Gepr.



f h

Ovalrelais 46

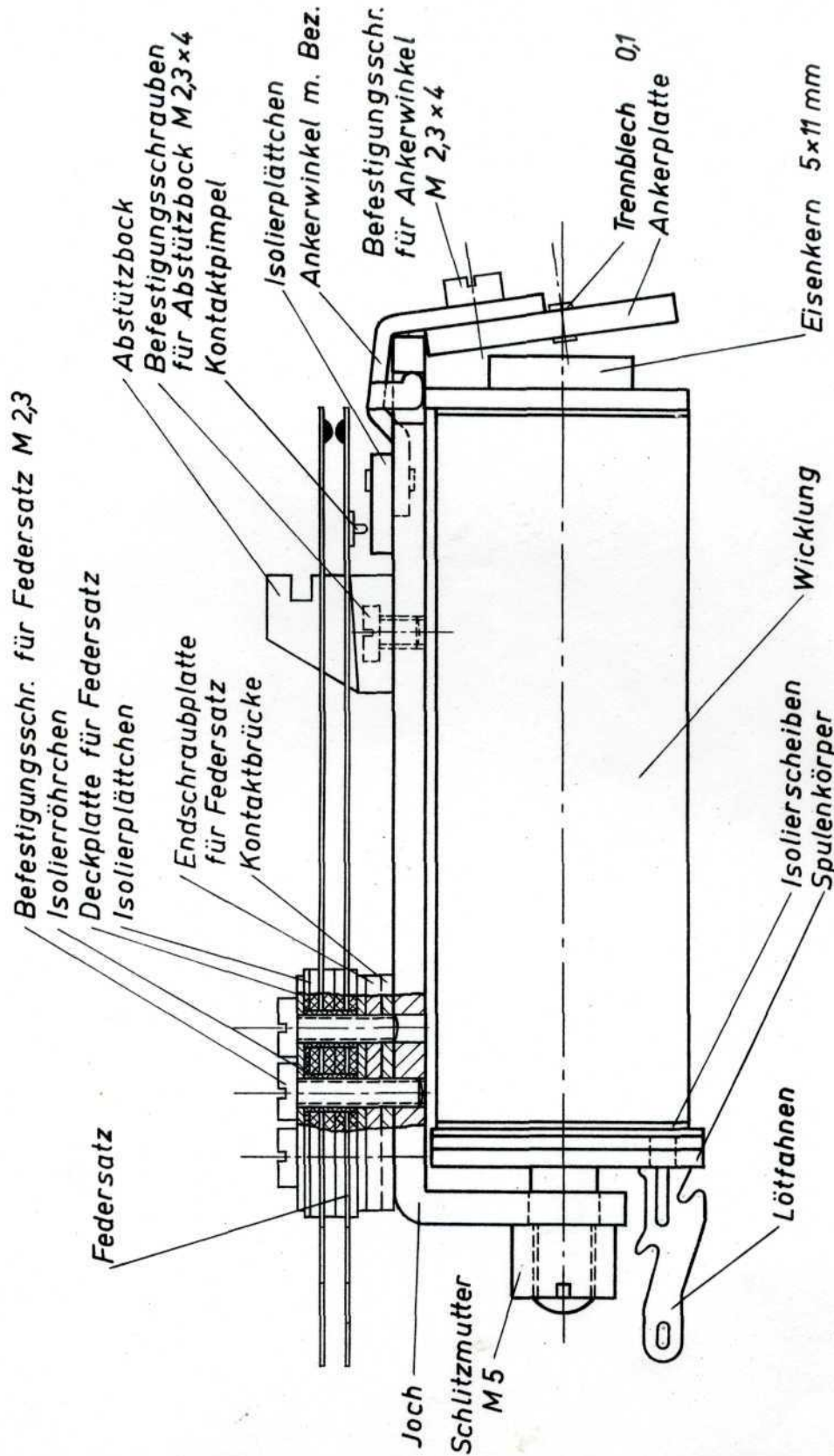

Telefonbau und Normalzeit
Frankfurt/Main
Ausbildungsabteilung

Ausg.	Tag	Name
-------	-----	------

Maßstab
2:1

Tag	Name
Gez.	1.2.63
Gepr.	

1
Anfangsknoten

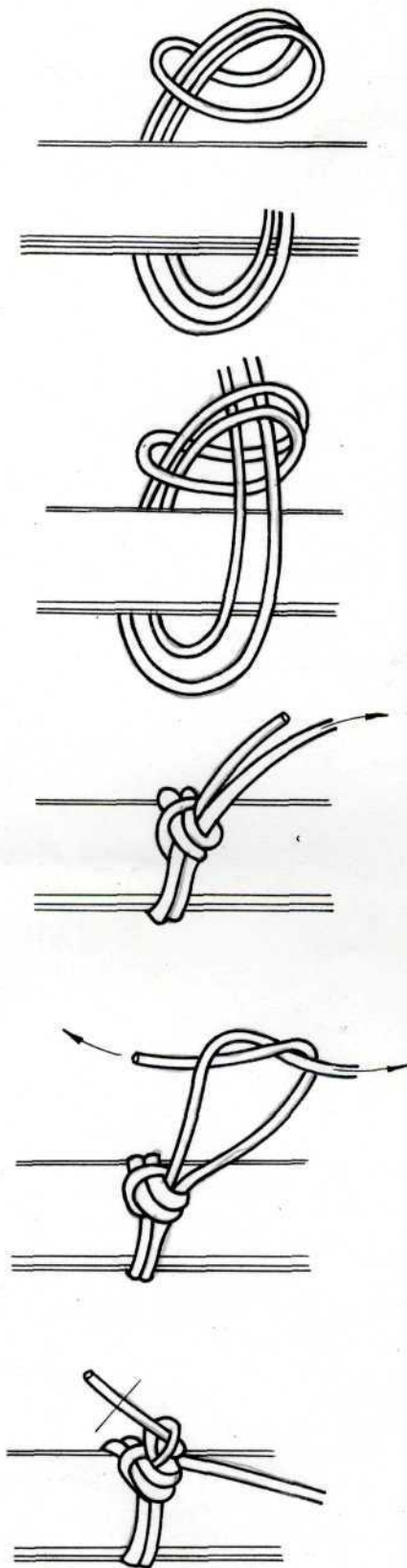

2
Zwischenknoten

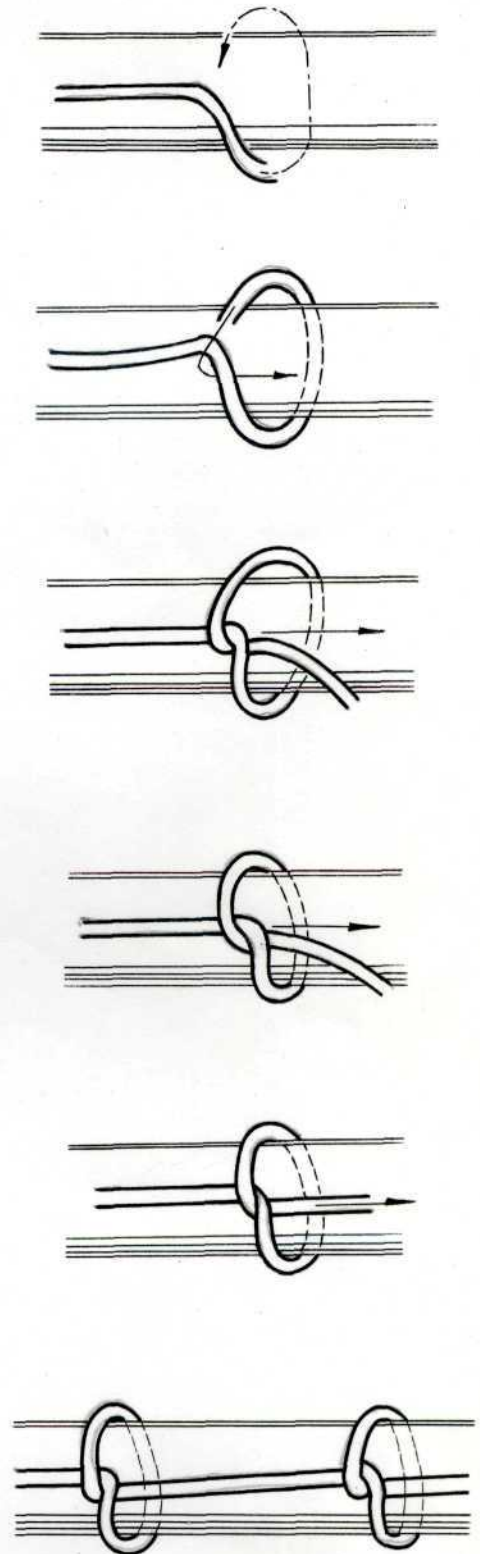

Lfd.Nr.	Zeichnung Nr.	Benennung	Stck.	Werkstoff		
 TELEFONBAU UND NORMALZEIT G. M. B. H.		Grundlehrgang		Maßstab	Tag	Name
				Gez.	8.10.63	Aliabadi
				Gepr.		
Ausbildungsabt.	Ausg. Tag Name	Knoten und Umschlingungen		zu P/342-2 Bl.1	Blatt	

Bindeisen

prov. Zugentlastung

prov. Zugentlastung

Bindeisen

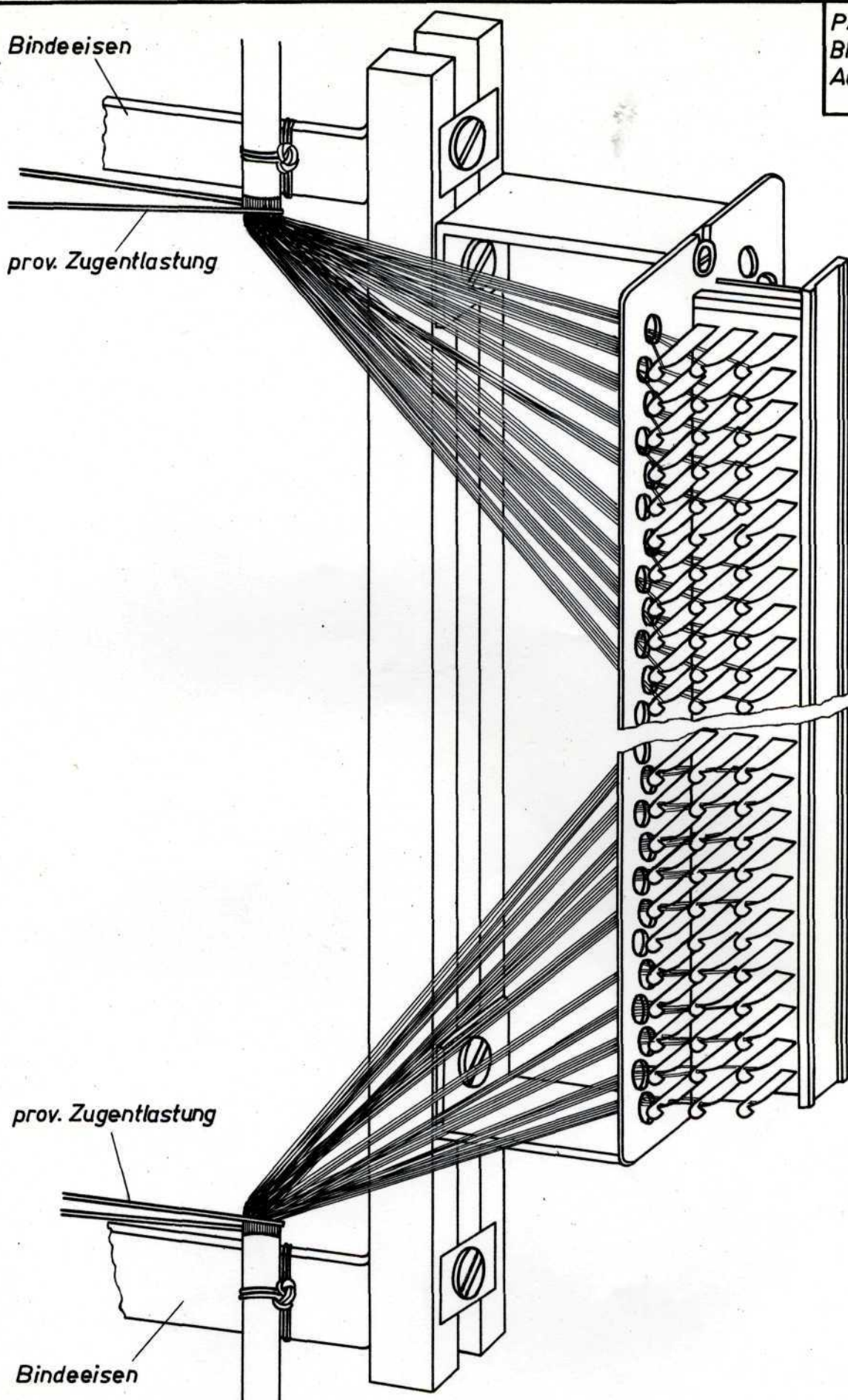

Lfd.Nr.	Zeichnung Nr.	Benennung	Stck.	Werkstoff		
 TELEFONBAU UND NORMALZEIT G. M. B. H.		Grundlehrgang		Maßstab	Tag	Name
					Gez.	
					Gepr.	
Ausbildungsabt.	Ausg. Tag	Name		Zu P/341-2 Bl. 7	Blatt F.H.	

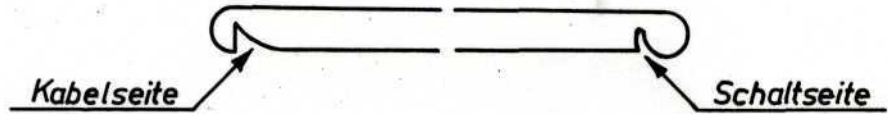

Kabel von oben

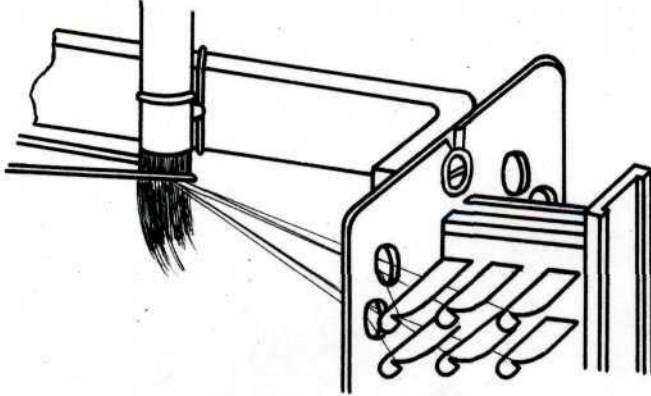

Durch Drahtführungslöcher gezogene Adern

Kabel von oben

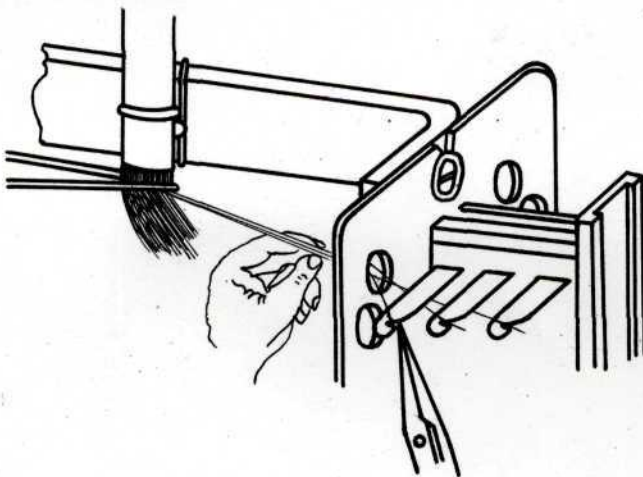

Adern vor Umlegen der Drahtenden

von unten

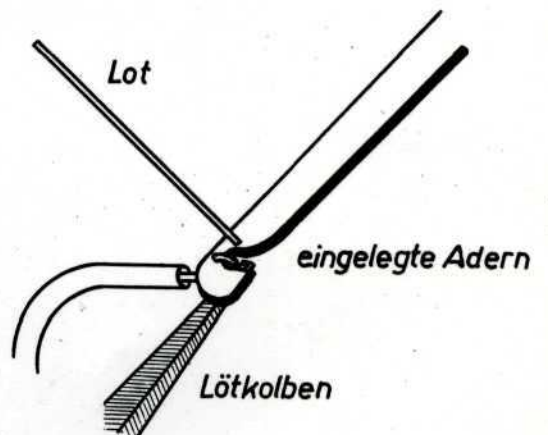
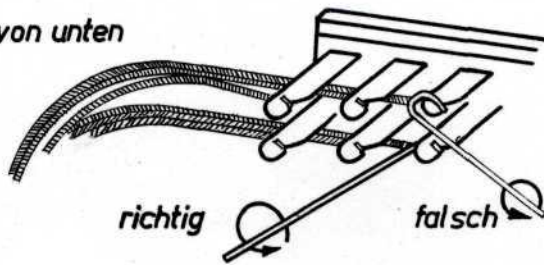

Lfd.Nr.	Zeichnung Nr.	Benennung	Stck.	Werkstoff		
		Grundlehrgang Beschalten des Lötösen- streifens		Maßstab	Tag	Name
					Gez.	
						Gepr.
Ausbildungsabt.		Ausg. Tag	Name			Blatt F.H.